

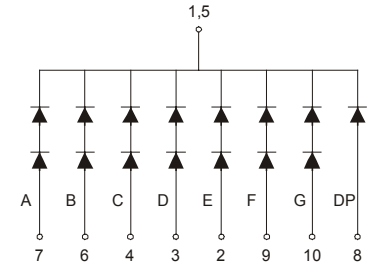

MCD-12011Ax-Bx (SINGLE DIGIT LED DISPLAY)

MCD-12011 Series

MCD-12011Ax

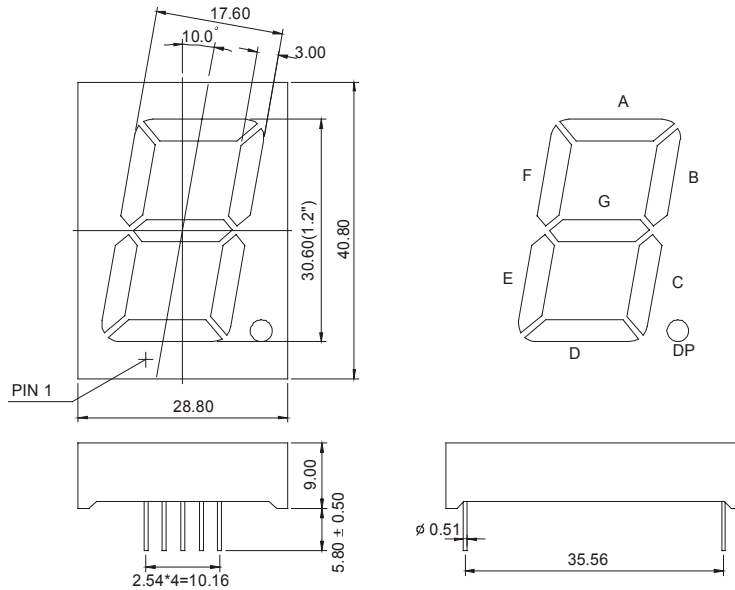

MCD-12011Bx

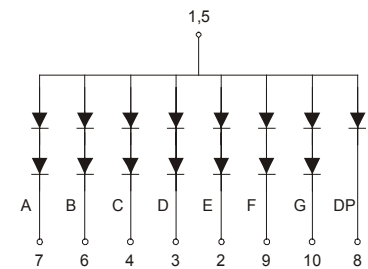

Features:

*1.2 INCH HIGH CHARACTER.

*EXCELLENT CHARACTER APPEARANCE.

*COMMON CATHODE OR COMMON ANODE.

*I.C. COMPATIBLE

*LOW POWER CONSUMPTION.

Part Number	EMITTED COLOR		Common Cathode or Common Anode	Peak Wavelength (nm)	Vf (v) Typ	If (mA)	Intensity Per Segment (mcd)	
							Min.	Typ.
MCD-12011AE	GaAsP/GaP	Hi. effi Red	Common Cathode	635	2.0	20	18	24
MCD-12011AG	GaP	Green		565	2.1	20	16	22
MCD-12011AY	GaAsP/GaP	Yellow		585	2.0	20	18	24
MCD-12011AS	GaAlAs	Super Red		660	1.8	20	20	26
MCD-12011AD	GaAlAs	Ultrs Red		660	1.8	20	50	60
MCD-12011AUE	AlGaInP	Ultra Red		625	2.0	20	60	70
MCD-12011AUY	AlGaInP	Ultra Yellow		590	2.0	20	60	70
MCD-12011BE	GaAsP/GaP	Hi. effi Red	Common Anode	635	2.0	20	18	24
MCD-12011BG	Gap	Green		565	2.1	20	16	22
MCD-12011BY	GaAsP/GaP	Yellow		585	2.0	20	18	24
MCD-12011BS	GaAlAs	Super Red		660	1.8	20	20	26
MCD-12011BD	GaAlAs	Ultrs Red		660	1.8	20	50	60
MCD-12011BUE	AlGaInP	Ultra Red		625	2.0	20	60	70
MCD-12011BUY	AlGaInP	Ultra Yellow		590	2.0	20	60	70