

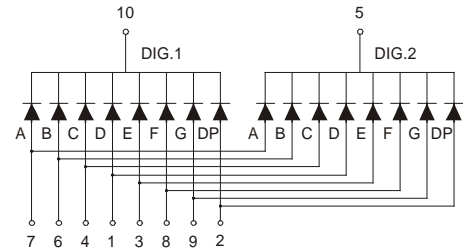

## MCD-4021Ax-Bx (DUAL DIGIT LED DISPLAY)

### MCD-4021 Series

### MCD-4021Ax

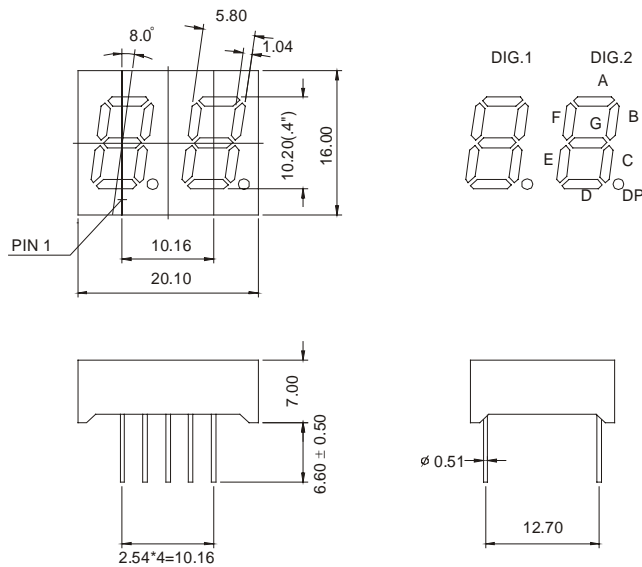

### MCD-4021Bx

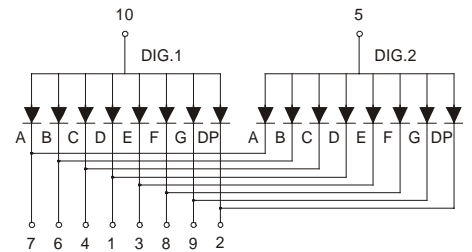

### Features:

\*0.40 INCH HIGH CHARACTER.

\*EXCELLENT CHARACTER APPEARANCE.

\*COMMON CATHODE OR COMMON ANODE.

\*I.C. COMPATIBLE.

\*LOW POWER CONSUMPTION.

Part Number	EMITTED COLOR		Common Cathode or Common Anode	Peak Wavelength (nm)	Vf (v) Typ	If (mA)	Intensity Per Segment (mcd)	
							Min.	Typ.
MCD-4021AE	GaAsP/GaP	Hi.effi Red	Common Cathode	635	2.0	20	9	12
MCD-4021AG	GaP	Green		565	2.1	20	8	11
MCD-4021AY	GaAsP/GaP	Yellow		585	2.0	20	9	12
MCD-4021AS	GaAlAs	Super Red		660	1.8	20	10	13
MCD-4021AD	GaAlAs	Ultra Red		660	1.8	20	25	30
MCD-4021AUE	AlGaInP	Ultra Red		625	2.0	20	30	35
MCD-4021AUY	AlGaInP	Ultra Yellow		590	2.0	20	30	35
MCD-4021BE	GaAsP/GaP	Hi.effi Red	Common Anode	635	2.0	20	9	12
MCD-4021BG	GaP	Green		565	2.1	20	8	11
MCD-4021BY	GaAsP/GaP	Yellow		585	2.0	20	9	12
MCD-4021BS	GaAlAs	Super Red		660	1.8	20	10	13
MCD-4021BD	GaAlAs	Ultra Red		660	1.8	20	25	30
MCD-4021BUE	AlGaInP	Ultra Red		625	2.0	20	30	35
MCD-4021BUY	AlGaInP	Ultra Yellow		590	2.0	20	30	35