

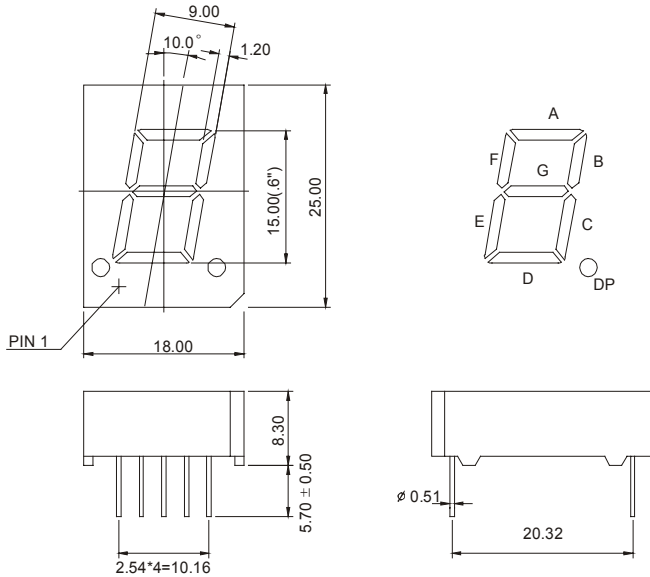

MCD-6011Ax-Bx (SINGLE DIGIT LED DISPLAY)

MCD-6011 Series



MCD-6011Ax

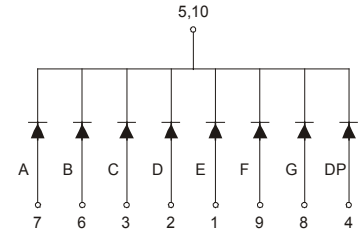

MCD-6011Bx

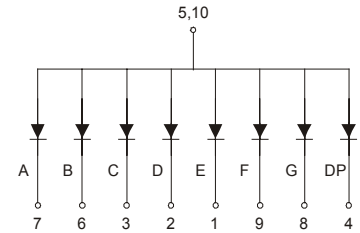

Features:

*0.60 INCH HIGH CHARACTER.

*EXCELLENT CHARACTER APPEARANCE.

*COMMON CATHODE OR COMMON ANODE.

*I.C. COMPATIBLE.

*LOW POWER CONSUMPTION.

Part Number	EMITTED COLOR		Common Cathode or Common Anode	Peak Wavelength (nm)	Vf (v) Typ	If (mA)	Intensity Per Segment (mcd)	
							Min.	Typ.
MCD-6011AE	GaAsP/GaP	Hi.effi Red	Common Cathode	635	2.0	20	9	12
MCD-6011AG	GaP	Green		565	2.1	20	8	11
MCD-6011AY	GaAsP/GaP	Yellow		585	2.0	20	9	12
MCD-6011AS	GaAlAs	Super Red		660	1.8	20	10	13
MCD-6011AD	GaAlAs	Ultra Red		660	1.8	20	25	30
MCD-6011AUE	AlGaInP	Ultra Red		625	2.0	20	30	35
MCD-6011AUY	AlGaInP	Ultra Yellow		590	2.0	20	30	35
MCD-6011BE	GaAsP/GaP	Hi.effi Red		Common Anode	635	2.0	20	9
MCD-6011BG	GaP	Green	565		2.1	20	8	11
MCD-6011BY	GaAsP/GaP	Yellow	585		2.0	20	9	12
MCD-6011BS	GaAlAs	Super Red	660		1.8	20	10	13
MCD-6011BD	GaAlAs	Ultra Red	660		1.8	20	25	30
MCD-6011BUE	AlGaInP	Ultra Red	625		2.0	20	30	35
MCD-6011BUY	AlGaInP	Ultra Yellow	590		2.0	20	30	35