

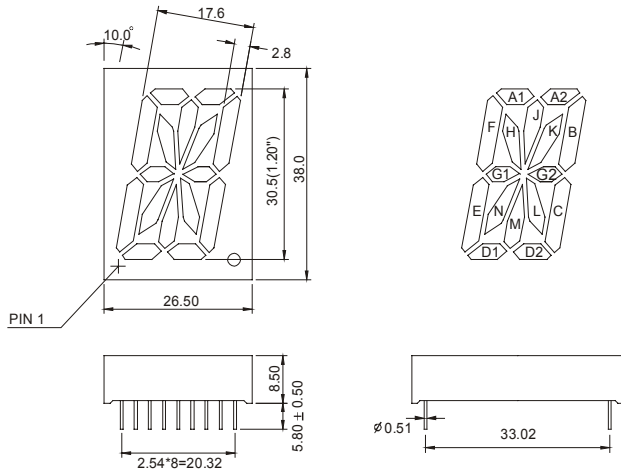

MCD-12012Ax-Bx (SINGLE DIGIT LED DISPLAY)

MCD-12012 Series



MCD-12012Ax

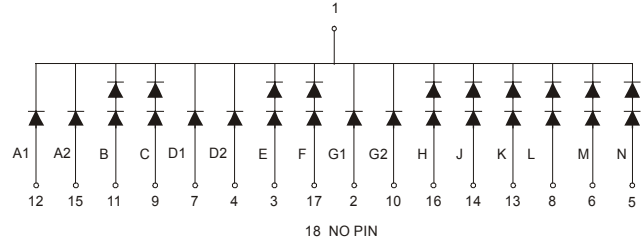

MCD-12012Bx

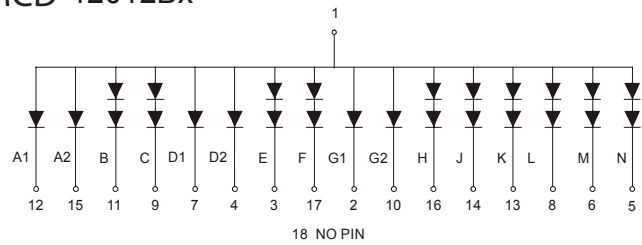

Features:

*1.2 INCH HIGH CHARACTER.

*EXCELLENT CHARACTER APPEARANCE.

*COMMON CATHODE OR COMMON ANODE.

*I.C. COMPATIBLE

*LOW POWER CONSUMPTION.

Part Number	EMITTED COLOR		Common Cathode or Common Anode	Peak Wavelength (nm)	Vf (v) Typ	If (mA)	Intensity Per Segment (mcd)	
							Min.	Typ.
MCD-12012AE	GaAsP/GaP	Hi. effi Red	Common Cathode	635	2.0	20	18	24
MCD-12012AG	GaP	Green		565	2.1	20	16	22
MCD-12012AY	GaAsP/GaP	Yellow		585	2.0	20	18	24
MCD-12012AS	GaAlAs	Super Red		660	1.8	20	20	26
MCD-12012AD	GaAlAs	Ultrs Red		660	1.8	20	50	60
MCD-12012AUE	AlGaInP	Ultra Red		625	2.0	20	60	70
MCD-12012AUY	AlGaInP	Ultra Yellow		590	2.0	20	60	70
MCD-12012BE	GaAsP/GaP	Hi. effi Red	Common Anode	635	2.0	20	18	24
MCD-12012BG	Gap	Green		565	2.1	20	16	22
MCD-12012BY	GaAsP/GaP	Yellow		585	2.0	20	18	24
MCD-12012BS	GaAlAs	Super Red		660	1.8	20	20	26
MCD-12012BD	GaAlAs	Ultrs Red		660	1.8	20	50	60
MCD-12012BUE	AlGaInP	Ultra Red		625	2.0	20	60	70
MCD-12012BUY	AlGaInP	Ultra Yellow		590	2.0	20	60	70