

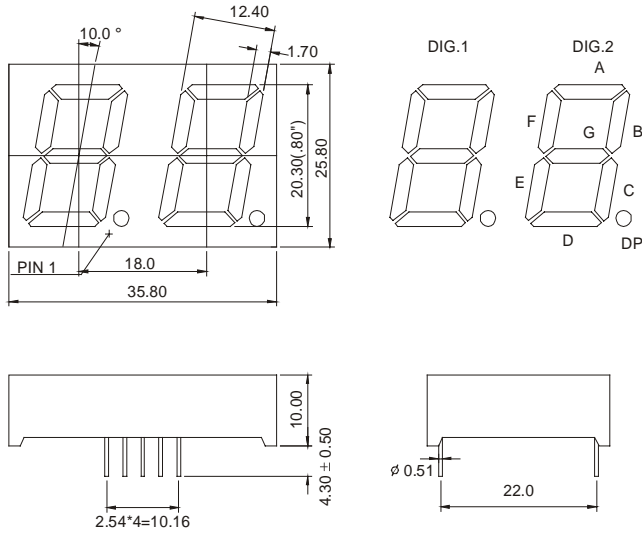

MCD-8021Ax-Bx (DUAL DIGIT LED DISPLAY)

MCD-8021 Series



MCD-8021Ax

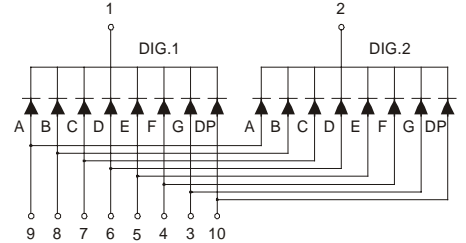

MCD-8021Bx

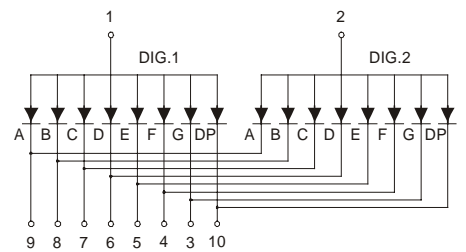

Features:

*0.8 INCH HIGH CHARACTER.

*EXCELLENT CHARACTER APPEARANCE.

*COMMON CATHODE OR COMMON ANODE.

*I.C. COMPATIBLE.

*LOW POWER CONSUMPTION.

Part Number	EMITTED COLOR		Common Cathode or Common Anode	Peak Wavelength (nm)	Vf (v) Typ	If (mA)	Intensity Per Segment (mcd)	
							Min.	Typ.
MCD-8021AE	GaAsP/GaP	Hi.effi Red	Common Cathode	635	2.0	20	9	12
MCD-8021AG	GaP	Green		565	2.1	20	8	11
MCD-8021AY	GaAsP/GaP	Yellow		585	2.0	20	9	12
MCD-8021AS	GaAlAs	Super Red		660	1.8	20	10	13
MCD-8021AD	GaAlAs	Ultra Red		660	1.8	20	25	30
MCD-8021AUE	AlGaInP	Ultra Red		625	2.0	20	30	35
MCD-8021AUY	AlGaInP	Ultra Yellow		590	2.0	20	30	35
MCD-8021BE	GaAsP/GaP	Hi.effi Red	Common Anode	635	2.0	20	9	12
MCD-8021BG	GaP	Green		565	2.1	20	8	11
MCD-8021BY	GaAsP/GaP	Yellow		585	2.0	20	9	12
MCD-8021BS	GaAlAs	Super Red		660	1.8	20	10	13
MCD-8021BD	GaAlAs	Ultra Red		660	1.8	20	25	30
MCD-8021BUE	AlGaInP	Ultra Red		625	2.0	20	30	35
MCD-8021BUY	AlGaInP	Ultra Yellow		590	2.0	20	30	35