

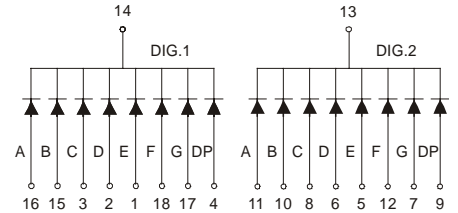

MCD-5622Ex-Fx (DUAL DIGIT LED DISPLAY)

MCD-5622 Series

MCD-5622Ex

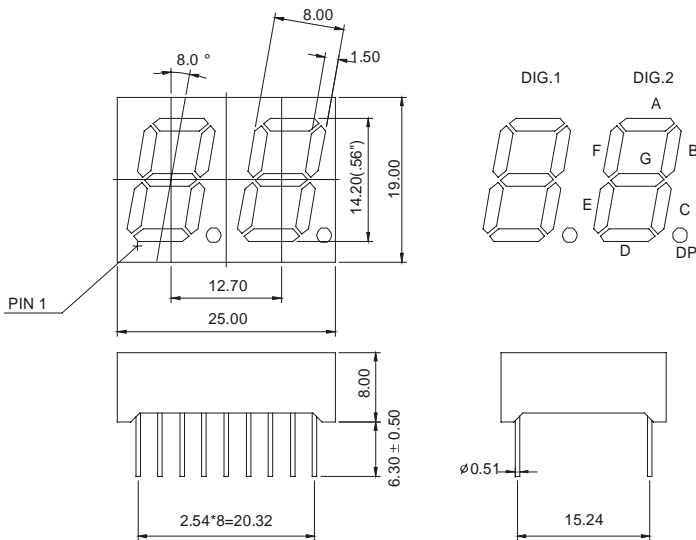

MCD-5622Fx

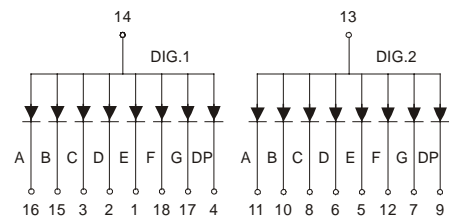

Features:

*0.56 INCH HIGH CHARACTER.

*EXCELLENT CHARACTER APPEARANCE.

*COMMON CATHODE OR COMMON ANODE.

*I.C. COMPATIBLE.

*LOW POWER CONSUMPTION.

Part Number	EMITTED COLOR		Common Cathode or Common Anode	Peak Wavelength (nm)	Vf (v) Typ	If (mA)	Intensity Per Segment (mcd)	
							Min.	Typ.
MCD-5622EE	GaAsP/GaP	Hi.effi Red	Common Cathode	635	2.0	20	9	12
MCD-5622EG	GaP	Green		565	2.1	20	8	11
MCD-5622EY	GaAsP/GaP	Yellow		585	2.0	20	9	12
MCD-5622ES	GaAlAs	Super Red		660	1.8	20	10	13
MCD-5622ED	GaAlAs	Ultra Red		660	1.8	20	25	30
MCD-5622EUE	AlGaInP	Ultra Red		625	2.0	20	30	35
MCD-5622EUY	AlGaInP	Ultra Yellow		590	2.0	20	30	35
MCD-5622FE	GaAsP/GaP	Hi.effi Red	Common Anode	635	2.0	20	9	12
MCD-5622FG	GaP	Green		565	2.1	20	8	11
MCD-5622FY	GaAsP/GaP	Yellow		585	2.0	20	9	12
MCD-5622FS	GaAlAs	Super Red		660	1.8	20	10	13
MCD-5622FD	GaAlAs	Ultra Red		660	1.8	20	25	30
MCD-5622FUE	AlGaInP	Ultra Red		625	2.0	20	30	35
MCD-5622FUY	AlGaInP	Ultra Yellow		590	2.0	20	30	35