

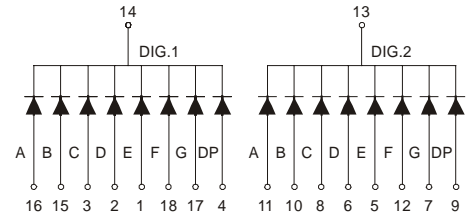

## MCD-5221Ax-Bx (DUAL DIGIT LED DISPLAY)

### MCD-5221 Series

### MCD-5221Ax

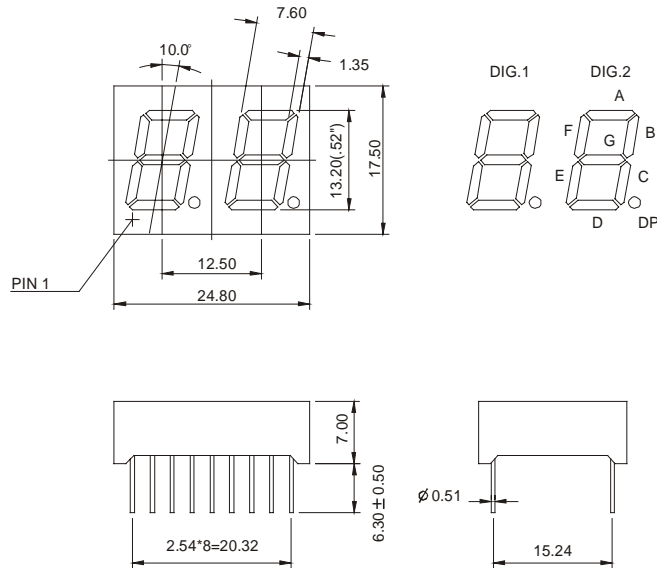

### MCD-5221Bx

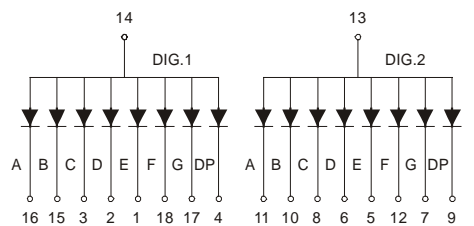

### Features:

\*0.52 INCH HIGH CHARACTER.

\*EXCELLENT CHARACTER APPEARANCE.

\*COMMON CATHODE OR COMMON ANODE.

\*I.C. COMPATIBLE.

\*LOW POWER CONSUMPTION.

Part Number	EMITTED COLOR		Common Cathode or Common Anode	Peak Wavelength (nm)	Vf (v) Typ	If (mA)	Intensity Per Segment (mcd)	
							Min.	Typ.
MCD-5221AE	GaAsP/GaP	Hi.effi Red	Common Cathode	635	2.0	20	9	12
MCD-5221AG	GaP	Green		565	2.1	20	8	11
MCD-5221AY	GaAsP/GaP	Yellow		585	2.0	20	9	12
MCD-5221AS	GaAlAs	Super Red		660	1.8	20	10	13
MCD-5221AD	GaAlAs	Ultra Red		660	1.8	20	25	30
MCD-5221AUE	AlGaInP	Ultra Red		625	2.0	20	30	35
MCD-5221AUY	AlGaInP	Ultra Yellow		590	2.0	20	30	35
MCD-5221BE	GaAsP/GaP	Hi.effi Red	Common Anode	635	2.0	20	9	12
MCD-5221BG	GaP	Green		565	2.1	20	8	11
MCD-5221BY	GaAsP/GaP	Yellow		585	2.0	20	9	12
MCD-5221BS	GaAlAs	Super Red		660	1.8	20	10	13
MCD-5221BD	GaAlAs	Ultra Red		660	1.8	20	25	30
MCD-5221BUE	AlGaInP	Ultra Red		625	2.0	20	30	35
MCD-5221BUY	AlGaInP	Ultra Yellow		590	2.0	20	30	35