

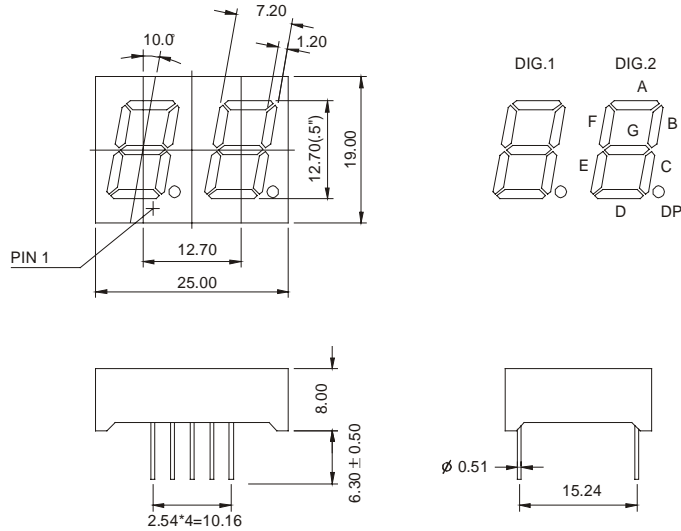

MCD-5021Ax-Bx (DUAL DIGIT LED DISPLAY)

MCD-5021 Series



MCD-5021Ax

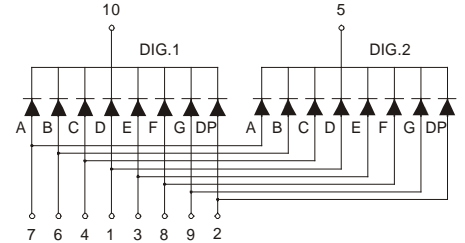

MCD-5021Bx

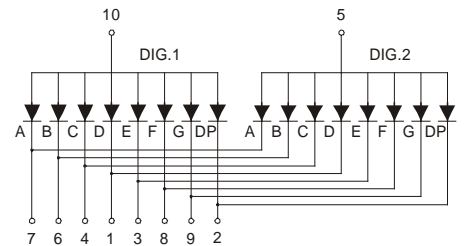

Features:

*0.50 INCH HIGH CHARACTER.

*EXCELLENT CHARACTER APPEARANCE.

*COMMON CATHODE OR COMMON ANODE.

*I.C. COMPATIBLE.

*LOW POWER CONSUMPTION.

Part Number	EMITTED COLOR		Common Cathode or Common Anode	Peak Wavelength (nm)	Vf (v) Typ	If (mA)	Intensity Per Segment (mcd)	
							Min.	Typ.
MCD-5021AE	GaAsP/GaP	Hi.effi Red	Common Cathode	635	2.0	20	9	12
MCD-5021AG	GaP	Green		565	2.1	20	8	11
MCD-5021AY	GaAsP/GaP	Yellow		585	2.0	20	9	12
MCD-5021AS	GaAlAs	Super Red		660	1.8	20	10	13
MCD-5021AD	GaAlAs	Ultra Red		660	1.8	20	25	30
MCD-5021AUE	AlGaInP	Ultra Red		625	2.0	20	30	35
MCD-5021AUY	AlGaInP	Ultra Yellow		590	2.0	20	30	35
MCD-5021BE	GaAsP/GaP	Hi.effi Red	Common Anode	635	2.0	20	9	12
MCD-5021BG	GaP	Green		565	2.1	20	8	11
MCD-5021BY	GaAsP/GaP	Yellow		585	2.0	20	9	12
MCD-5021BS	GaAlAs	Super Red		660	1.8	20	10	13
MCD-5021BD	GaAlAs	Ultra Red		660	1.8	20	25	30
MCD-5021BUE	AlGaInP	Ultra Red		625	2.0	20	30	35
MCD-5021BUY	AlGaInP	Ultra Yellow		590	2.0	20	30	35